



Grille Plenum Chambers

Introduction

Correct selection and sizing of distribution plenum chambers is critical because grille air resistance is very low relative to the distribution ductwork resistance. It is therefore recommended that whenever possible grilles are served by low velocity stub ducts from branch ducting systems fitted with correct balancing controls.

Where it is necessary to specify and use grille plenums a generous allowance for commissioned noise generation should be made.

Product Description

- PBG** Individual grille plenum
- PBG/LL** Low line grille plenum
- NRG** Neck reducer
- PBLG** Linear grille plenum
- PBLG/LL** Low line linear grille plenum
- PBSG** Security grille plenum

Spigot Options

- SE Side Entry
- TE Top Entry
- 1CC 1- Circular Connection
- 1RC 1- Rectangular/Square Connection
- 1FO 1- Flat Oval Connection

Features

- Plated steel with stitched seam joints.
- Standard circular connection diameters: 97, 122, 157, 197, 247, 312 and 397 Ø
- Available with circular, square, rectangular or flat oval spigots in either top or side entry applications
- Standard or Low-line configurations
- Optional 6mm internal thermal/acoustic lining

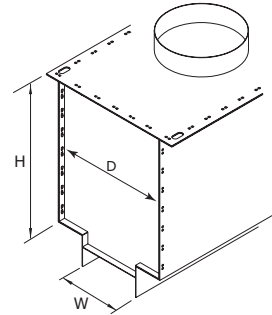

PBLG/LL - Top entry Low-line linear grille plenum box.

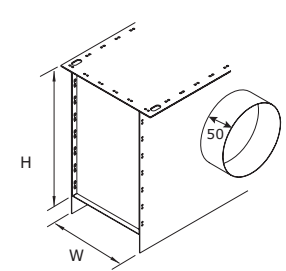

PBLG - Side entry Linear grille plenum box.

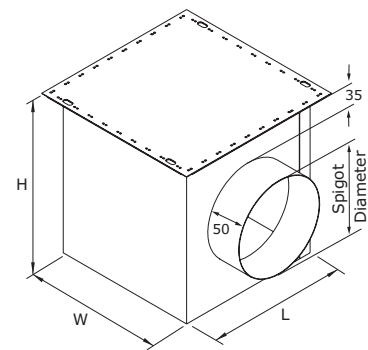

PBG - Side entry grille plenum box

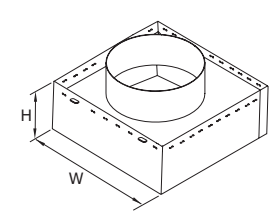

NRG - Neck Reducer

Control Options

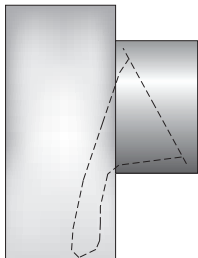

FDC
Cord operated flap damper for mounting within circular spigots to plenum chambers. The cord should be fed through the air terminal device ready for commissioning.

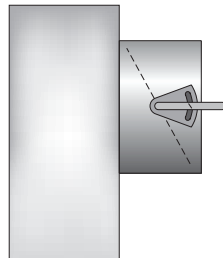

FDQ
Flap damper with external quadrant control for mounting within circular spigots to plenum chambers. The quadrant is accessible from outside the duct and the damper can be locked in any position.

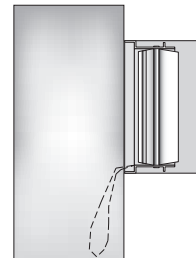

OBCO
Cord operated opposed blade damper for installation within square or rectangular spigots to plenum chambers. The cord should be fed through the air terminal device ready for commissioning.

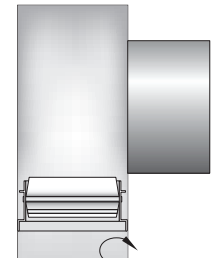

OBSS / ED
Standard opposed blade damper for diffuser or duct mounting. Adjustable by screwdriver inside the duct or through the face of the air terminal device. The ED is an individually adjustable blade device for equalising airflow across the diffuser.

Finish

PBG/NRG Galvanised sheet steel

Dimensions

- Length Extract Grille length
- Width Extract Grille width
- Height SE – Spigot diameter or height + 100mm as standard
- TE – as specified by customer (200mm minimum recommended)

Order

When ordering plenum chambers please specify length, width & height, spigot size and position (Top or Side Entry) and control options. Please note that the plenum height should in general be 100mm greater than the spigot diameter (Side Entry applications).

ORDER EXAMPLE

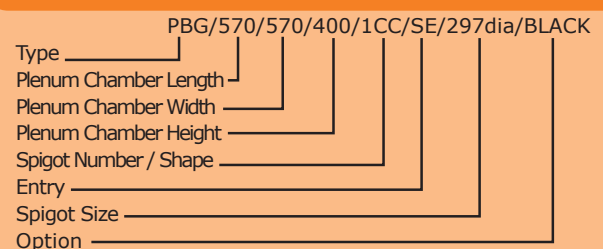



Controls and Fixing Options

Fixing Options

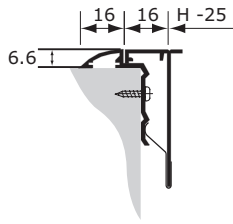

Frame: R16
Mounting: RCCF

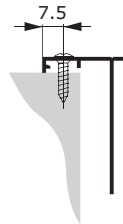

Frame: R25 / R32
Mounting: SF

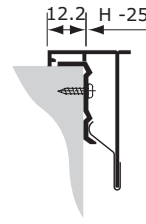

Frame: R25 / R32
Mounting: AFCF

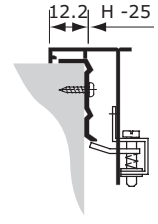

Frame: R25 / R32
Mounting: AFHS

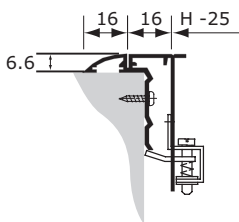

Frame: R16
Mounting: RCHS

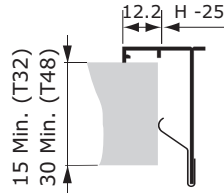

Frame: R16 / R25 / R32
Mounting: CF

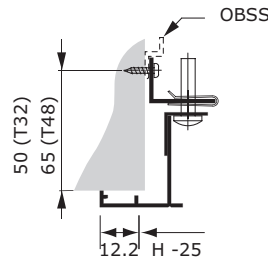

Frame: R16 / R25 / R32
Mounting: CRB

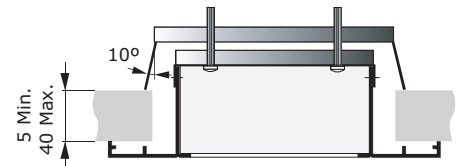

BSSBD (R16 / R25 / R32)
Duct / Plasterboard fixing

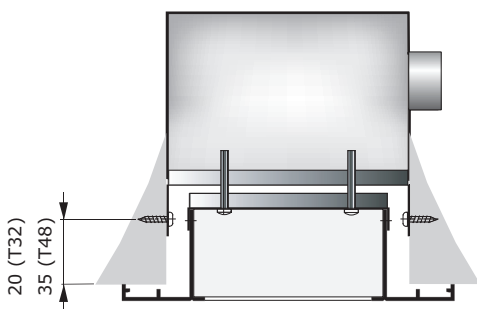

BSSBP (R16 / R25 / R32)
Plenum fixing (-15mm)

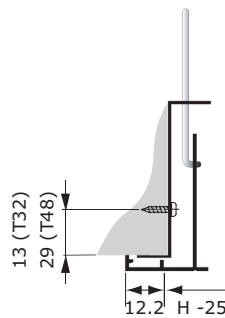

Frame: R25
Mounting: AFVS

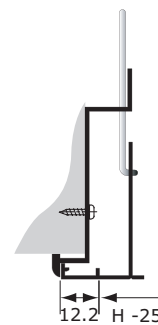

Frame: R25
Mounting: PFVS

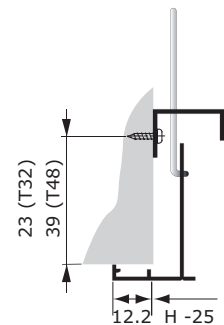

Frame: R16 / R25 / R32
Mounting: VS



Standard Frames

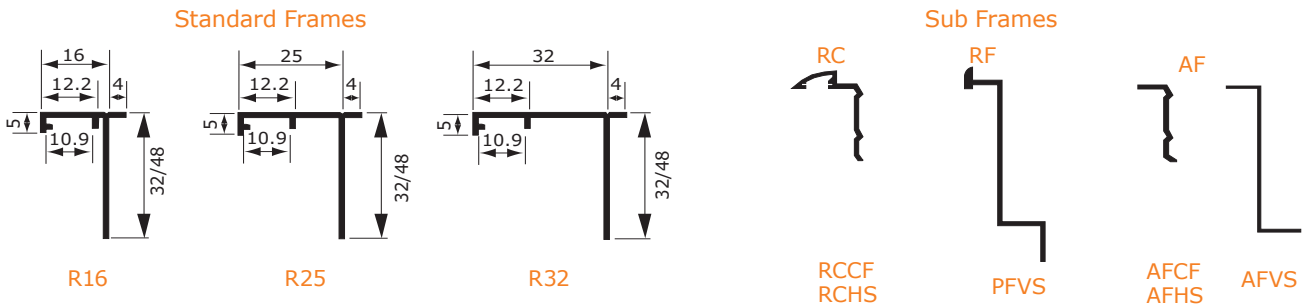

Overall Grille Sizes
Grille with R16 = Nominal W/H + 7mm
Grille with R25 = Nominal W/H + 25mm
Grille with R32 = Nominal W/H + 39mm
Grille with RC = Nominal W/H + 39mm
Grille with PF = Nominal W/H + 21mm

Note:

AF and RC subframes can be made to a maximum size of 800mm in any direction in one piece. For sizes above that, we supply in parts for assembly on site by others.

DT-2M - Duct Fitted

The hinged strip is used to calibrate the amount of air desired, by altering the angle of the blades and therefore altering the amount of disruption to the airflow.

Sizes for DT-2M

Width = 100 - 1225

Height = 75 - 425

Correction for Grille + Damper		
Supply 0° spread	dBA + 2	$P_s \times 1.3$
Supply 45° spread	dBA + 2	$P_s \times 1.1$
Exhaust	dBA + 2	$P_s \times 1.2$

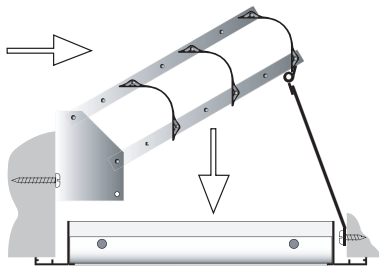

Grille Nominal Sizes

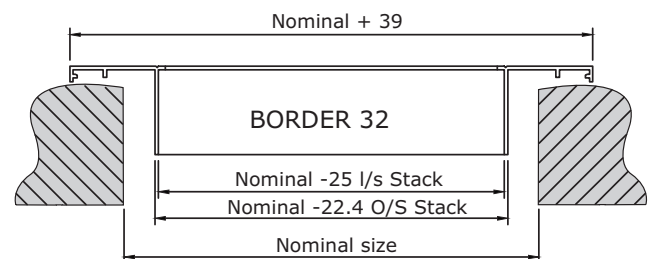
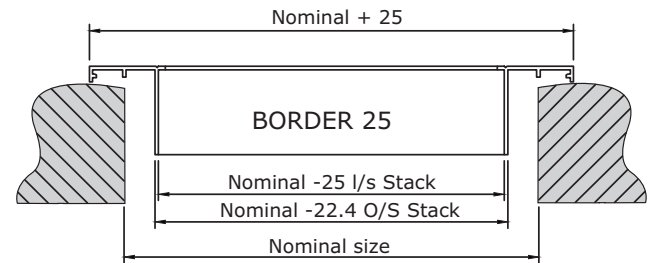
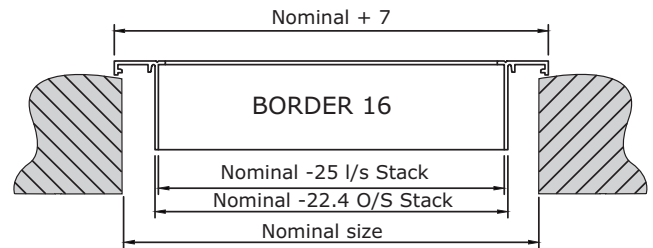



Grille Fixing Selection

Types	SF	CF	CRB	VS	AFVS	PFVS	BSSB	AFCF	AFHS	RCCF	RCHS
1H / 2H / 1V / 2V	A/C	A	A/C	A/C	A/C	A/C	A/B/C	A	A/C	A	A/C
1KH / 2KH	A/C										
1KV / 2KV	A/C										
1HM / 2HM	A/C										
1VM / 2VM	A/C										
PER / 3HF	A/C	A		A/C	A/C	A/C		A		A	
GC5 / 3HG / 3HJ	A/C	A	A/C	A/C	A/C	A/C	A/B/C	A	A/C	A	A/C
ALF / 2ALF	A/C	A		A/C	A/C	A/C		A		A	
ALN / ALM / ALG / ALJ	A/C	A	A/C	A/C	A/C	A/C	A/B/C	A	A/C	A	A/C
ALG2 / ALJ2	A/C	A	A/C	A/C	A/C	A/C		A	A/C	A	A/C
ALM2 / ALN2	A/C	A	A/C	A/C	A/C	A/C		A	A/C	A	A/C
2ALM / 2ALJ / ALG10 / ALJ10	A/C	A		A/C	A/C	A/C		A		A	A/C
NSA / NSB / DVA / DVB	A/C										
DVC / NSC	A/C	A		A/C	A/C	A/C		A		A	
RTC / 2RTC	A/C										
BORDER STYLES	25T/32T	16T/25T/32T	16T/25T/32T	16T/25T/32T	25T/32T	25T	RTC/16T 25T/32T	25T/32T	25T/32T	16T/RTC-R16	16T/RTC-R16

A = SUITABLE FOR DUCTING AND WALL
 B = SUITABLE FOR PLASTERBOARD
 C = SUITABLE FOR CEILING

Removable Cores

Types	Removable	RCCF	RCHS	PFVS	AV	AFCF	AFHS	RTC	RCG - GC5	Special
1H/2H/1V/2V	Grille	B	B	B	N	N	N			
PER/GC5	Grille	B	B	B	N	N	N			
RCG - GC5	Core								B	
3HG/3HJ	Grille	B	B	B	N	N	N			
3HG/3HJ	Core							B		B
3HF/ALF	Grille	B		B	N	N				
3HF/3HJ	Core							B		B
ALN/ALM/ALG/ALJ	Grille	B	B	B	N	N	N			
ALN/ALM/ALG/ALJ	Core							B		B
APN/APM/APG/APJ	Core									
ALG10/ALJ10	Grille	B		B	N	N				
ALG10/ALJ10	Core							B		B
NSC/DVC	Grille	B		B	N	N				
RTC/2RTC	Grille	B								
RTC/2RTC	Core							B		

B = BEADED FRAME
 N = NON BEADED FRAME
 RTC = R5 OR R16 FRAME WITH CORE AND PACKERS
 SPECIAL = PART 6200001 FRAME WITH CORE AND BRACKET INCORPORATING TERRY CLIP
 Note: If OBSS or ED are selected access to the duct work will not be possible.



Control Options - Grille Mounted OBSS Opposed Blade Damper (Volume Control Damper)

Introduction

Waterloo OB Opposed Blade Dampers are manufactured to suit virtually the whole of our square / rectangular Air Terminal range and can be fitted to the neck of the terminals or inside plenum box.

They are adjustable from the front of the Grille or Diffuser with a screwdriver as standard, but are also available with cord- or lever-operation.

Manufactured with linked aluminium extruded blades, in sizes to suit any Waterloo Grille or Diffuser, they are useful for fine airflow regulation and can be adjusted from fully open to closed low-leakage position.

Product Description

- OBSS** Opposed Blade Damper, Screwdriver operated
- OBCO** Opposed Blade Damper, Cord operated
- OBSL** Opposed Blade Damper, Short Lever operated
- OBLL** Opposed Blade Damper, Long Lever operated
- BLACK** Painted black to prevent through vision

Features

- Linked aluminium extrusions for limited extra weight
- Large choice of adjustments to suit any configuration
- Can be fitted to virtually any Waterloo Grille or Diffuser

Finishes

Extruded aluminium blades

Sizes

Minimum Size - 100 x 75

Minimum Size for Plasterline - 100 x 50

Maximum Size - single section 800x600mm

Multiple sections will be banked to accommodate larger terminal sizes.

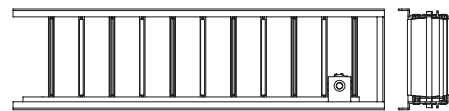
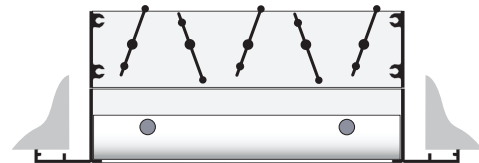
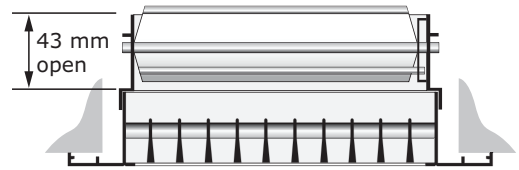

ORDER EXAMPLE

OBSS/Black/600/200/For ALN

Damper type _____

Options _____

Terminal Length _____

Terminal Width _____

Terminal type _____

ED Equalising Dampers (Directional Blades Incapable of Shut Off)

Introduction

Waterloo ED Equalising Dampers are manufactured to suit virtually the whole of our square / rectangular Air Terminal range and can be fitted to the neck of the terminals or inside plenum box.

They are individually adjustable to control air direction and may be used for localised blanking.

Manufactured with aluminium extruded blades, in sizes to suit any Waterloo Grille or Diffuser, they can be adjusted manually by removing the Grille or Diffuser core.

Product Description

- ED** Equalising deflector
- BLACK** Painted black to prevent through vision

Features

- Aluminium extrusions for limited extra weight
- Individually adjustable for fine airflow regulation
- Can be fitted to virtually any Waterloo Grille or Diffuser

Finishes

Extruded aluminium blades

Sizes

Minimum Size - 100 x 50

Maximum Size - single section 800x600mm

Multiple sections will be banked to accommodate larger terminal sizes.

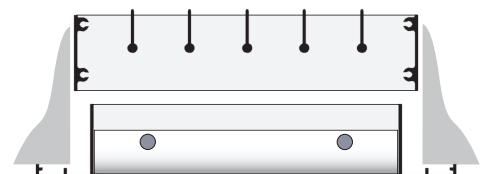
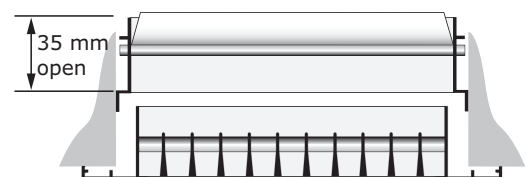

ORDER EXAMPLE

ED/Black/600/200/For A CSF

Damper type _____

Options _____

Terminal Length _____

Terminal Width _____

Terminal type _____



Technical Information

Basis of Throw

Unless noted differently on the individual supply grille performance information, all Throw performance data is based on isothermal supply air conditions, to a terminal velocity (v_t), in the centre of the jet, of 0.5 m/s. See tables below for other conditions.

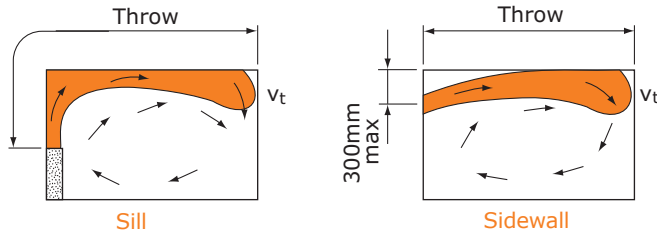

Remark:

If the distance between grille and ceiling is more than 300 mm, the throw will be reduced by 30%.

Jet Temperature Decay Characteristics

The following graph indicates the jet residual temperature at various throw distances.

- Given throw = x (m) and supply air differential = ΔT_o
- Calculate $\sqrt{Ac} = \sqrt{\text{Grille Area (m}^2\text{)}}$
- Calculate x/\sqrt{Ac}
- Enter graph at required value x/\sqrt{Ac}
- Exit graph at value $\Delta T_x / \Delta T_o$
- Calculate $\Delta T_x = \Delta T_o \times (\Delta T_x / \Delta T_o)$
- ΔT_x = Residual temperature differential ($^{\circ}\text{C}$)

Working Example for Temperature Decay Calculations

1H/300/150/R25/SF

- Supply Air Temp = 18 $^{\circ}\text{C}$
- Room Temp = 20 $^{\circ}\text{C}$
- ΔT_o = 2 $^{\circ}\text{C}$
- Air Volume = 200 l/s
- From Performance data see page 24
- Throw = 8.32 m
- $x\sqrt{Ac} = 8.32 / \sqrt{(0.3 \times 0.15)} = 39.22$
- Therefore = $\Delta T_x = 0.375^{\circ}\text{C}$ and the air temperature at maximum throw (8.32 m) is = 19.6 (19.625) $^{\circ}\text{C}$

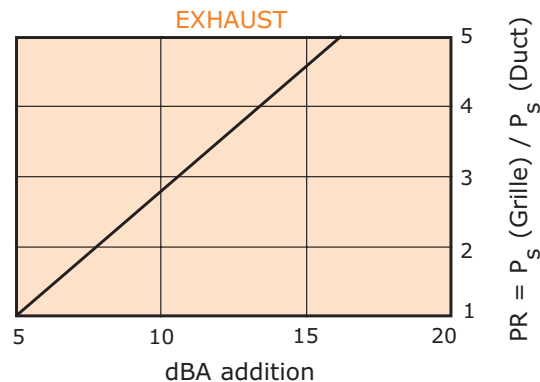
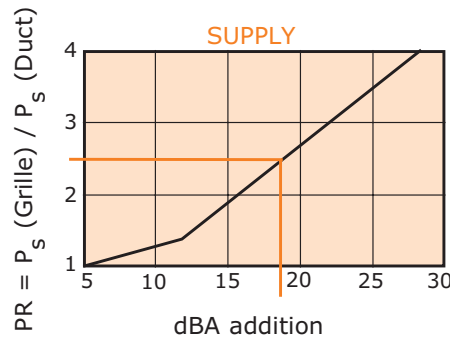
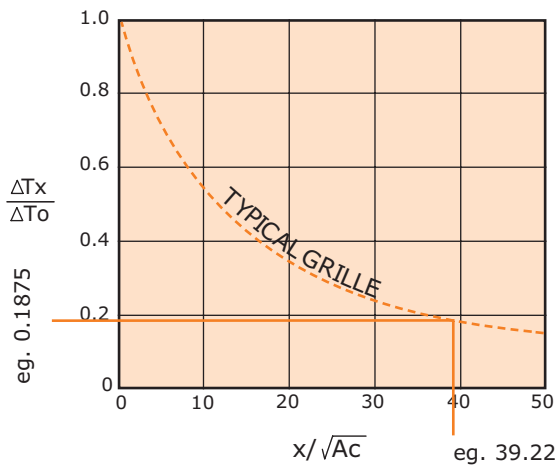

Example of Throttled Damper Factor Handling

Consider a Supply Grille with Damper

P_s (Grille) = 50 Pa

P_s (Duct) = 20 Pa

PR = 2.5

Therefore addition is = 18 dBA

Assume that we are using the same grille as in the Temperature Decay Calculation (above);

From the Performance data on page 8,

dBA = 30 + 18 = 48 dBA