

waterloo



# High Flow Diffuser

HFC High Flow Coanda

HFD High Flow Directional

HFC-PL High Flow Coanda Plasterline

HFD-PL High Flow Directional Plasterline

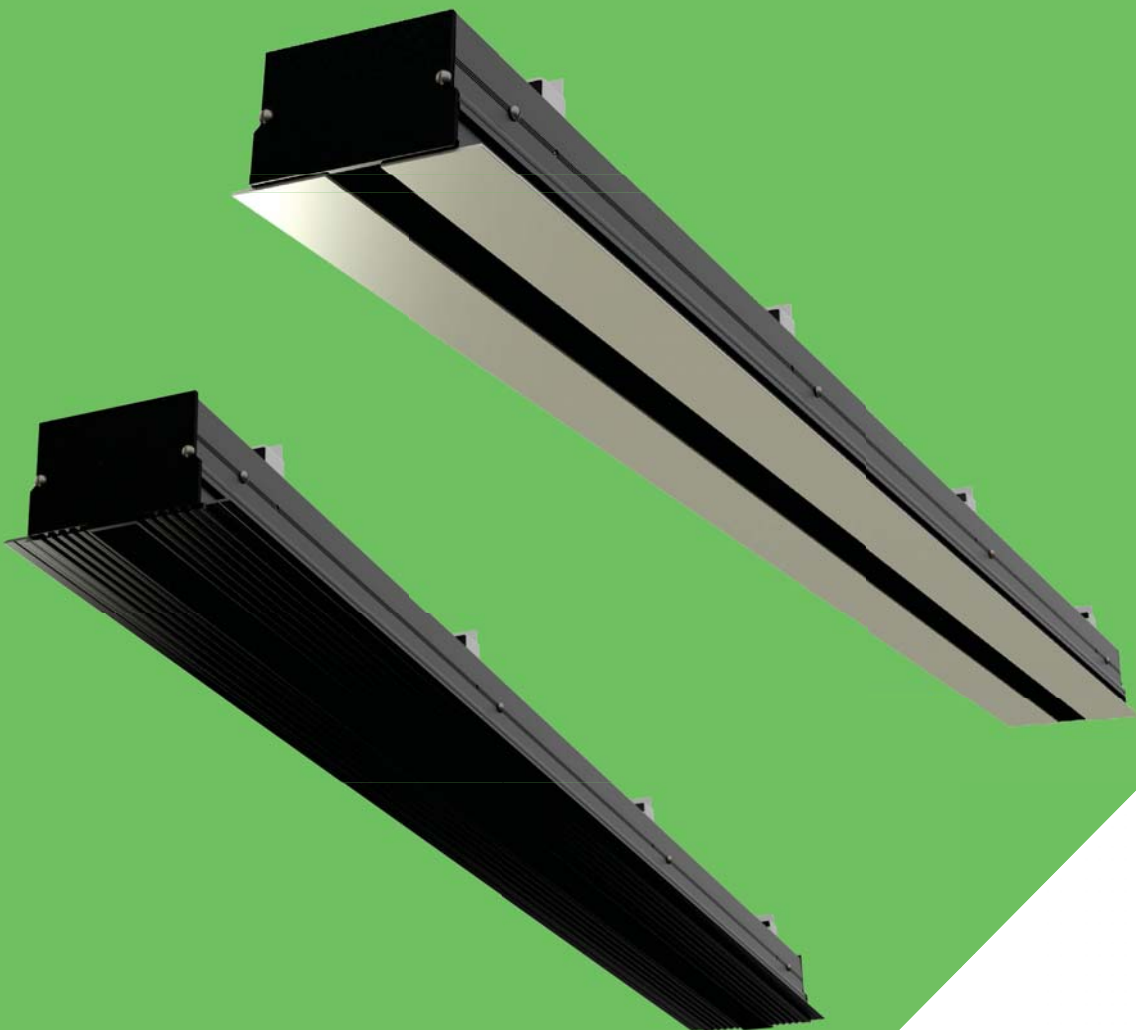



## High Flow Diffuser

### HFC / HFD

#### Introduction

The Waterloo High Flow diffusers are designed to give exceptional performance and the visual appearance of an architectural shadow gap that has become a very desirable design feature within buildings.

High Flow Diffusers are available in two variants: HFC (High Flow Coanda), which is usually ceiling mounted, providing a horizontal throw through the Coanda effect; and HFD (High Flow Directional) which is generally mounted in a wall for directional, horizontal projection of air into a space or provide a coanda throw if positioned close to a horizontal surface.

High Flow diffusers are designed to accommodate a dynamic range of air volume, from high to low. Featuring an excellent air distribution pattern to eliminate draughts in the occupied zone. Available as a single slot and sectional for continuous, linear runs.

HFC and HFD are manufactured using aluminium extrusions and features easily adjustable, hidden air pattern control elements.

The standard bordered version is available with an RAL polyester powder coated border with black anodised internals.

The Plasterline version (PL) is available when a plastered in product is required, the internals of the products have a black anodised finish to maintain the shadow gap appearance.

#### Product Description

- HFC** High Flow Coanda
- HFD** High Flow Directional
- HFC-PL** High Flow Coanda Plasterline
- HFD-PL** High Flow Directional Plasterline

#### Features

- Dynamic capacity from high to low values
- Strong coanda pattern for best performance
- Hidden control elements
- Continuous joint detail for linear runs
- 3 slot sizes available

#### Finishes

- HFC/D  
PPG9010 (RAL 9010 Gloss - 80% Gloss White)  
PPM9010 (RAL 9010 Matt - 20% Gloss White)  
PPM9006 (RAL 9006 Matt - 30% Gloss Silver)  
Other colours available on request
- HFC/D-PL  
Anodised black only

#### Sizes

3 standard slot sizes are available  
25mm, 40mm and 60mm, standard  
module lengths are 1500mm.

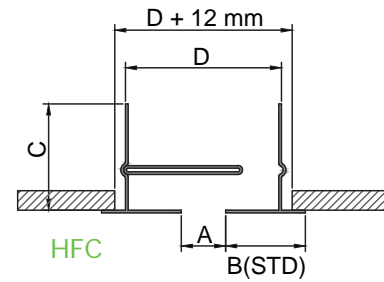

HFC

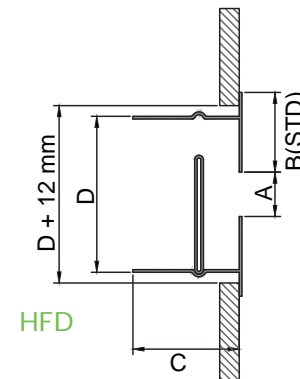

HFD

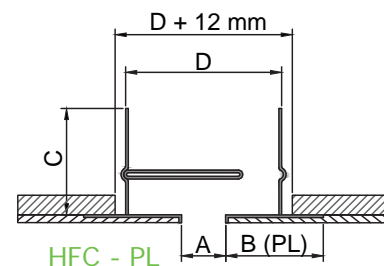

HFC - PL

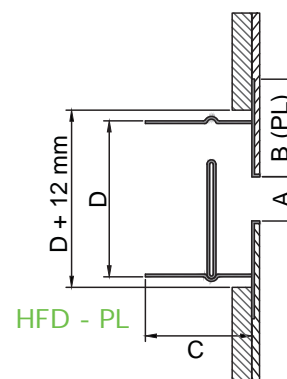

HFD - PL

**ORDER EXAMPLE**

HFC/25/1800/PPM9010/ENDS

Type \_\_\_\_\_

Slot size \_\_\_\_\_

Length \_\_\_\_\_

Finish \_\_\_\_\_

Ends caps \_\_\_\_\_

Dim Size	25	40	60
A	25	40	60
B (STD)	45	45	45
B (PL)	55	55	55
C	60	60	60
D	88	103	123



## High Flow Diffuser - Coanda ceiling

### HFC

#### Selection Criteria

2.7m ceiling height, increase throw by 1m for every increase of 1m in ceiling height.

Horizontal throw is based on 10°C cooling.

#### Selection Example

##### HFC/40/1000

Total air flow rate = 130 l/s  
 Maximum throw = 7.2m  
 Pressure drop = 20Pa  
 Sound = 36dBA

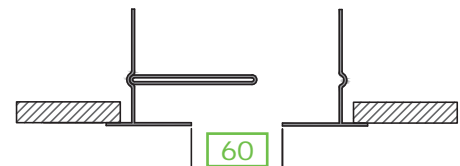
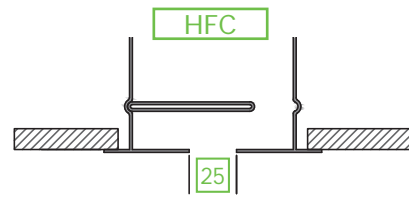

Length corrections					
Active Length (m)	0.5	1.25	2.0	2.5	3.0
dBA Reduction	-8	-5	-3	-2	0
Throw multiplier	0.45	0.65	0.8	0.9	1.0

#### Performance Nomogram

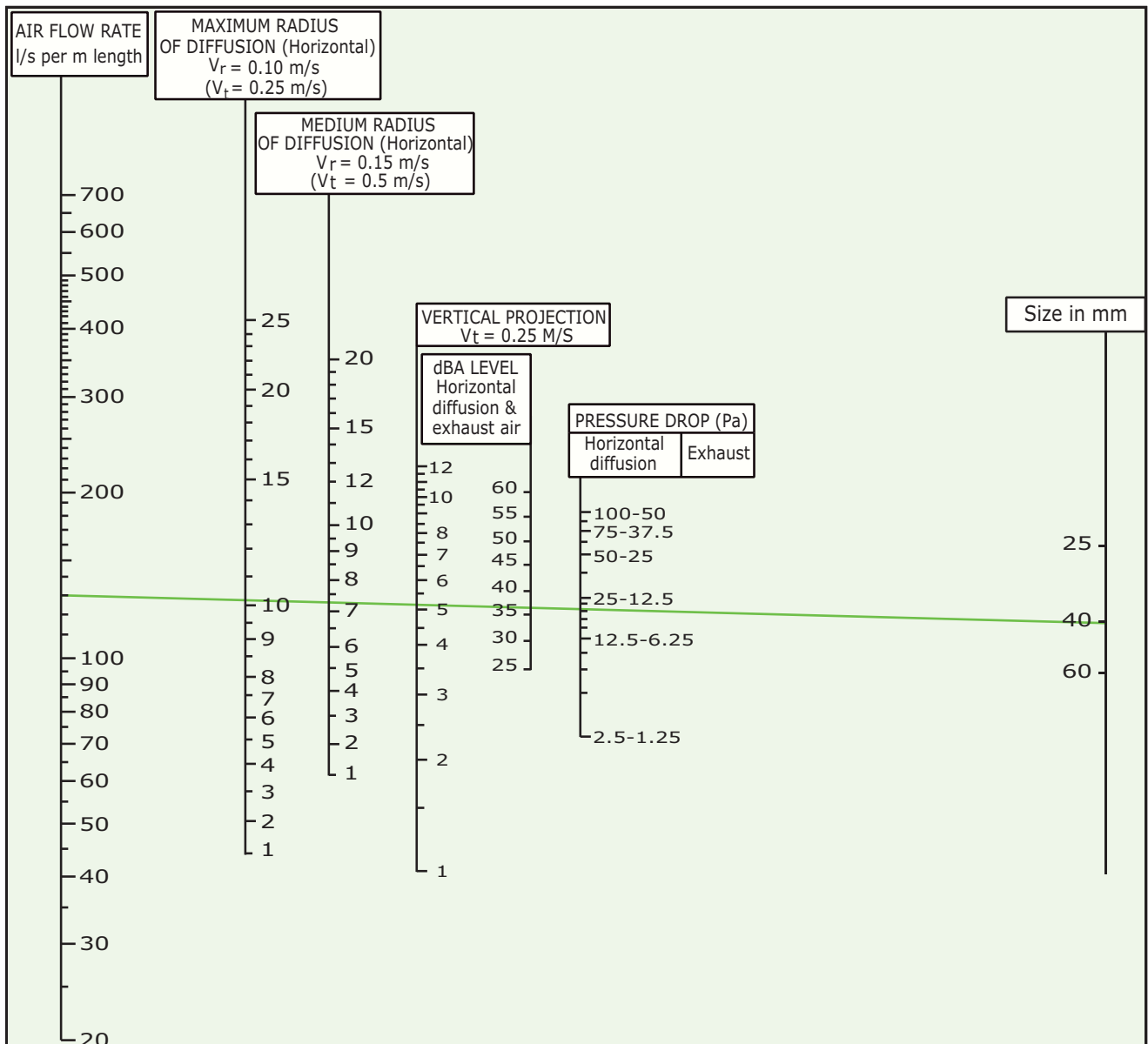



## High Flow Diffuser - Side wall

### HFD

#### Selection Criteria

##### HFD Side wall

0° Horizontal throw

#### Selection Example

##### HFD/40/1000

Total air flow rate = 80 l/s  
 Maximum throw = 4.8m  
 Pressure drop = 20Pa  
 Sound = 30dBA

Note: 25LP is a lower pressure model that has very limited control on the direction of the air flow.

If air is directed along the ceiling throw correction will be x 1.25.

Length corrections					
Active Length (m)	0.5	1.25	2.0	2.5	3.0
dBA Reduction	-8	-5	-3	-2	0
Throw multiplier	0.45	0.65	0.8	0.9	1.0

#### Performance Nomogram

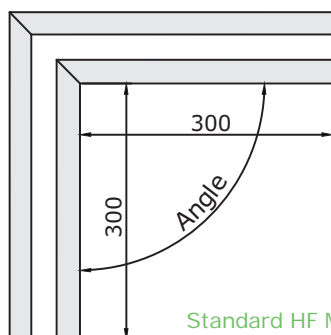
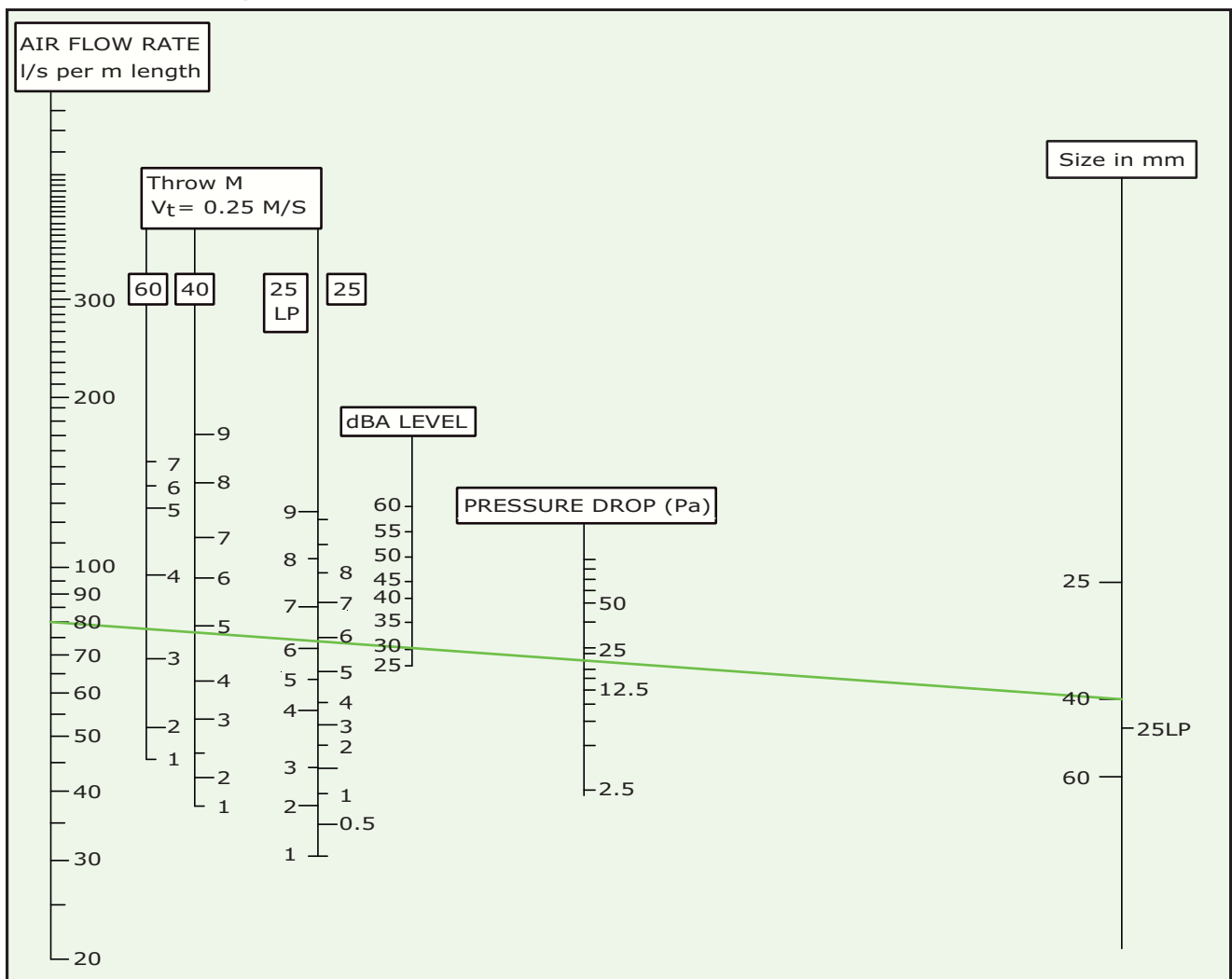

Standard HF Mitred Corner



## High Flow Diffuser - Extract

HFC / HFD

Performance Nomogram

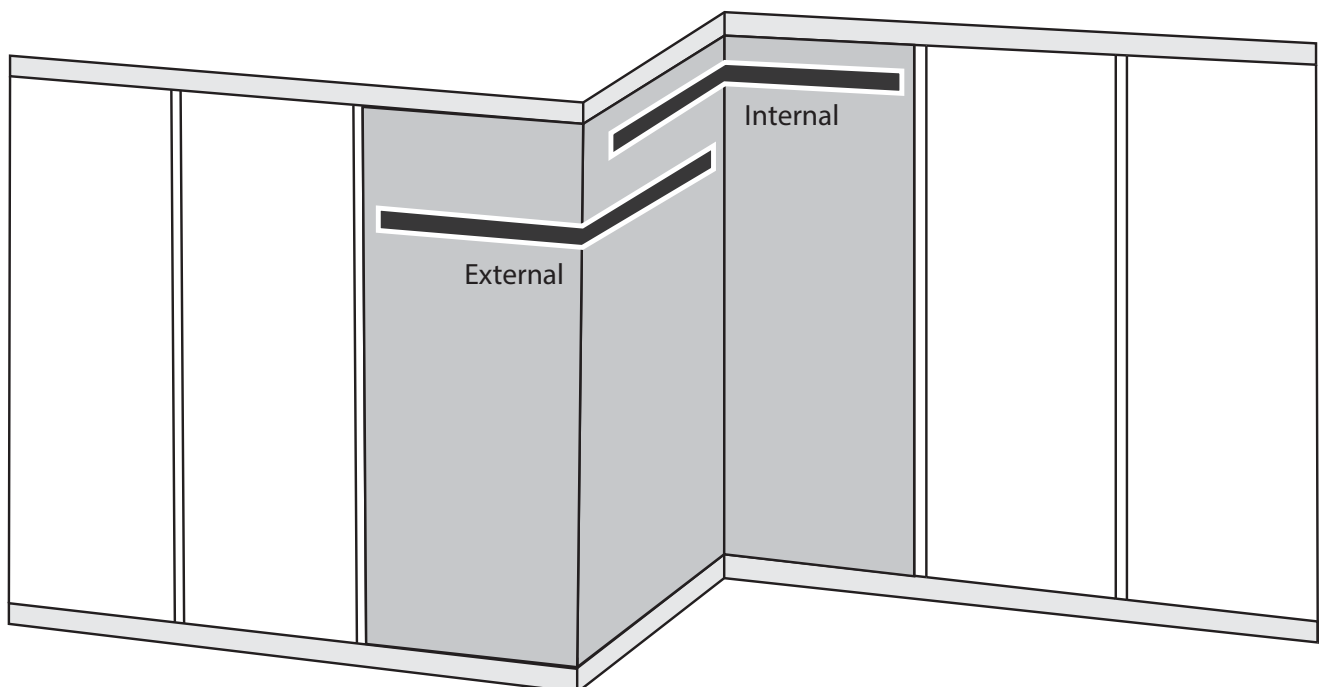
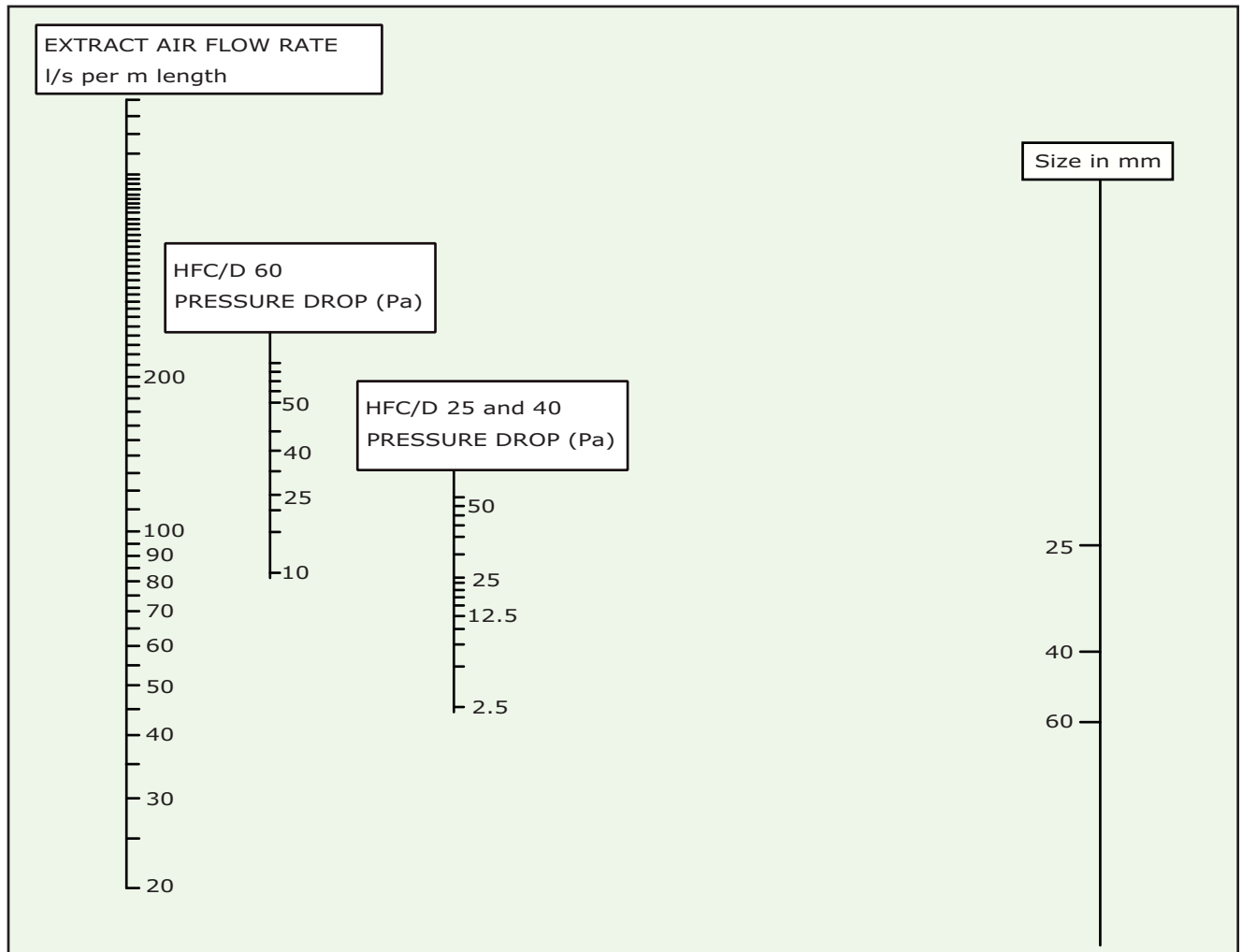

Standard High flow diffuser external and internal



## High Flow Diffuser - Side wall HFC / HFD

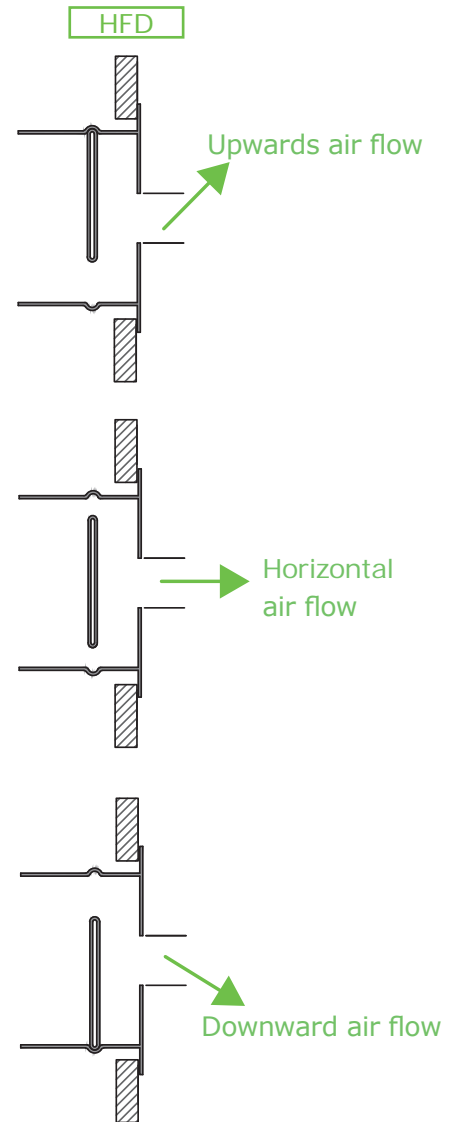
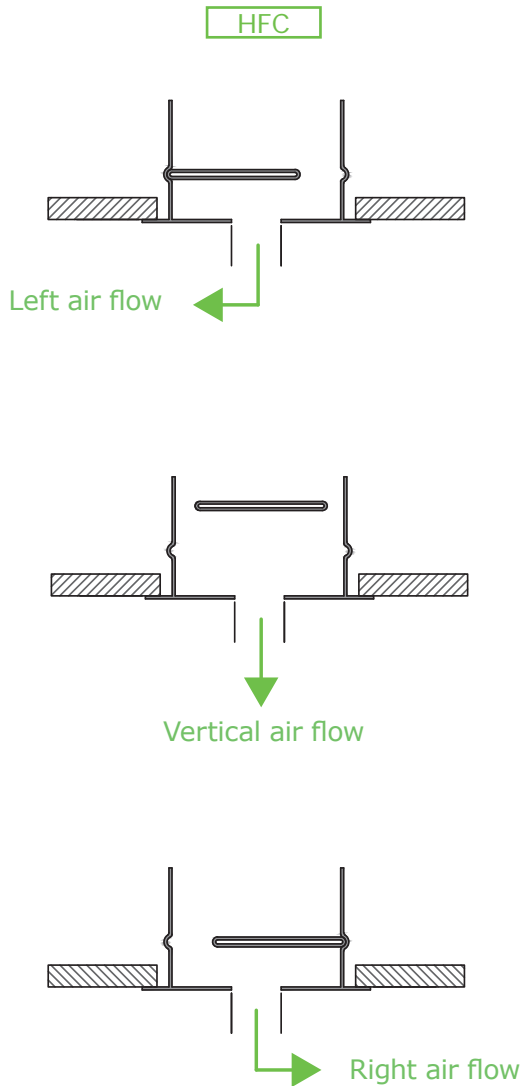

Standard End Caps				
Diffuser style	Dim L1	Dim L2	Dim L3	Dim L4
HFC/HFD	Nominal Length	Nominal Length + 3	Nominal Length + 19	Nominal Length + 56
HFC/HFD-PL	Nominal Length	Nominal Length + 6	Nominal Length + 8	Nominal Length + 6

Nominal length = inside of stack  
Note: HFC/HFD has 28mm end caps

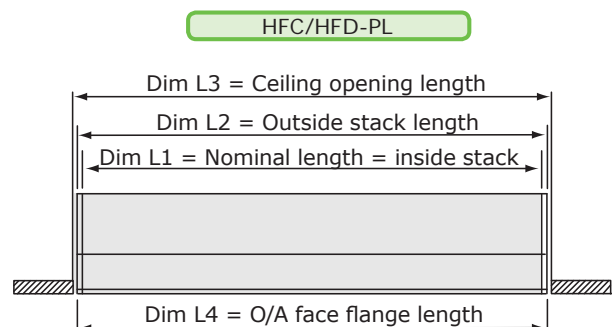
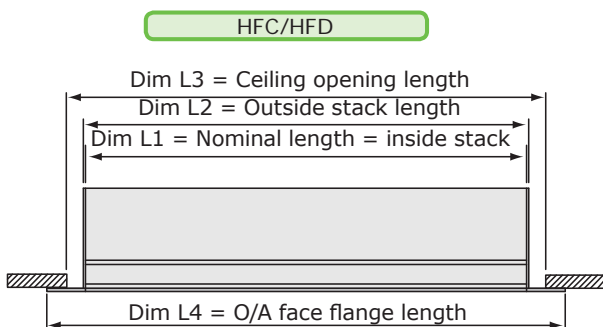



## Plenum Boxes

### Introduction

Our High- / Low- Line plenum boxes are designed to guarantee a good distribution of the air prior to diffusion through the terminals. Available with Side or Top Entry connections to customer-specific diameter/shape, these can be fitted with Spigot Flap Dampers, cord- / quadrant-operated, as well as 6mm acoustic lining (optional) reaction to fire class C-s3-d0 to EN 13501-1: 2007 to avoid noise generation. Also available with rivet fix (hem fix as standard).

### Product Description

- PBHL** High-Line Plenum box to suit CS / LCS / DSL / HF Linear Slot Diffusers
- PBLL** Low-Line Plenum box to suit CS / LCS / DSL / HF Linear Slot Diffusers
- PBHLB** High-Line Plenum box to suit CSB Barrel Slot Diffusers
- PBLLB** Low-Line Plenum box to suit CSB Barrel Slot Diffusers
- PBHLH** High-Line Plenum box to suit FCD Fan Coil Diffusers
- PBLLH** Low-Line Plenum box to suit FCD Fan Coil Diffusers
- SE** Side Entry spigot
- TE** Top Entry spigot
- CC** Circular Connection
- RC** Rectangular Connection
- FO** Flat Oval Connection
- FDC** Cord-operated Flap Damper (optional)
- FDQ** Quadrant-operated Flap Damper (optional)
- LINED** 6mm acoustic lining (optional) reaction to fire class C-s3-d0 to EN 13501-1: 2007
- BFL** Internal perforated plate for Supply air diffusers (optional)
- BLACK** Plenum painted black to prevent through vision (optional)

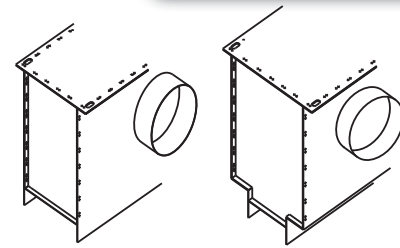
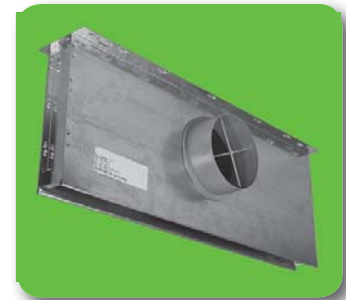

High-Line plenum box

Low-Line plenum box

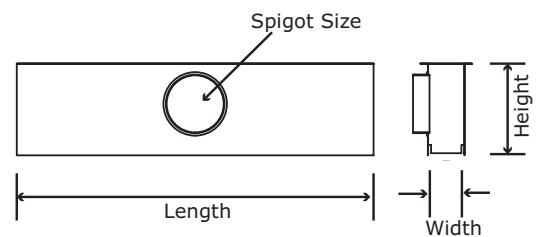

### Features

- Galvanised steel, stitch fixed
- Available in High-Line or Low-Line to accommodate larger spigot sizes
- 1 to 4 connections – Circular, Rectangular or Flat Oval (reduced plenum height)
- Side or Top Entry spigots with optional airflow control damper
- Slotted holes on top plate for easy drop rod installation

### Finish

Galvanised sheet steel

### Dimensions

- Length PBHLH / Fan Coil Diffuser length  
PBHL, PBHLB / Linear Slot diffuser length
- Width PBHLH / Fan Coil Diffuser width  
PBHL, PBHLB / Number of slots
- Height SE – Spigot diameter or height + 100mm as standard  
TE – as specified by customer (200mm minimum recommended)

### Order

When ordering plenum boxes please specify length, width & height, spigot size and position (Top or Side Entry) and control options. Please note that the plenum height should in general be 100mm greater than the spigot diameter (Side Entry applications).

### ORDER EXAMPLE

PBHL/HF/2/1200/250/250/SE/147/2CC/OBSS/LINED

Type \_\_\_\_\_

Diffuser type \_\_\_\_\_

Number of slots \_\_\_\_\_

Plenum box Length \_\_\_\_\_

Plenum box Width \_\_\_\_\_

Plenum box Height \_\_\_\_\_

Entry position \_\_\_\_\_

Spigot Size \_\_\_\_\_

Spigot Number / Shape \_\_\_\_\_

Option \_\_\_\_\_

Option \_\_\_\_\_

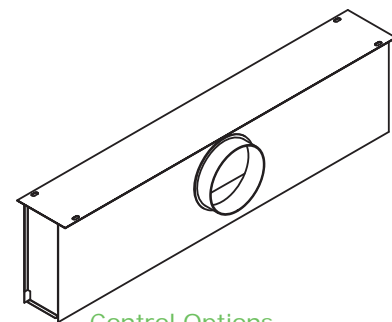

Control Options

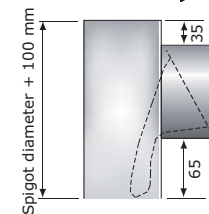

FDC

Cord operated flap damper for mounting within circular spigots to plenum boxes.

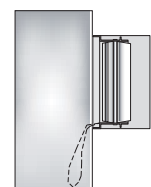

OBCO

Cord operated opposed blade damper for installation within square or rectangular plenum spigots.

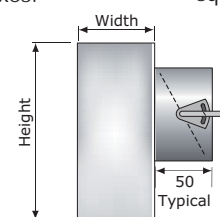

FDQ

Flap damper with external quadrant control for mounting within circular spigots to plenum boxes.



## Plenum Chambers

### Selection Criteria (Using the Nomogram)

By way of example, referring to the data in the CS section, consider a diffuser handling 180 l/s total with a pressure drop of 25Pa. Projecting from this volume through the diffuser pressure loss, then pivot on the plenum dimensions to suit the diffuser 2 slot width, which gives a minimum plenum height of approx 280mm. Draw a line from the air flow selection point through the required spigot air velocity and read off the nearest standard spigot size. In this example the spigot diameter exceeds the selected plenum height, so the height now becomes 315 + 100 = 415mm.

Alternatively, to maintain the original height, select a suitably sized rectangular spigot (300 x 200 in the example) or use multiple circular spigots.

### Installation

The plenum boxes and neck reducers are supported by four drop rods through a locating hole positioned near each corner.

**Note:** Actual spigot diameter is nominal - 3mm (i.e. 200mm is 197mm actual).

**Note:** Plenum length is determined by linear diffuser selection.

Recommended max air volume for 3 m/s, 35 dBA based on recommended spigot sizes							
Diameter	97	122	157	197	247	312	397
l/s	22	35	58	92	144	229	370

### Performance Nomogram

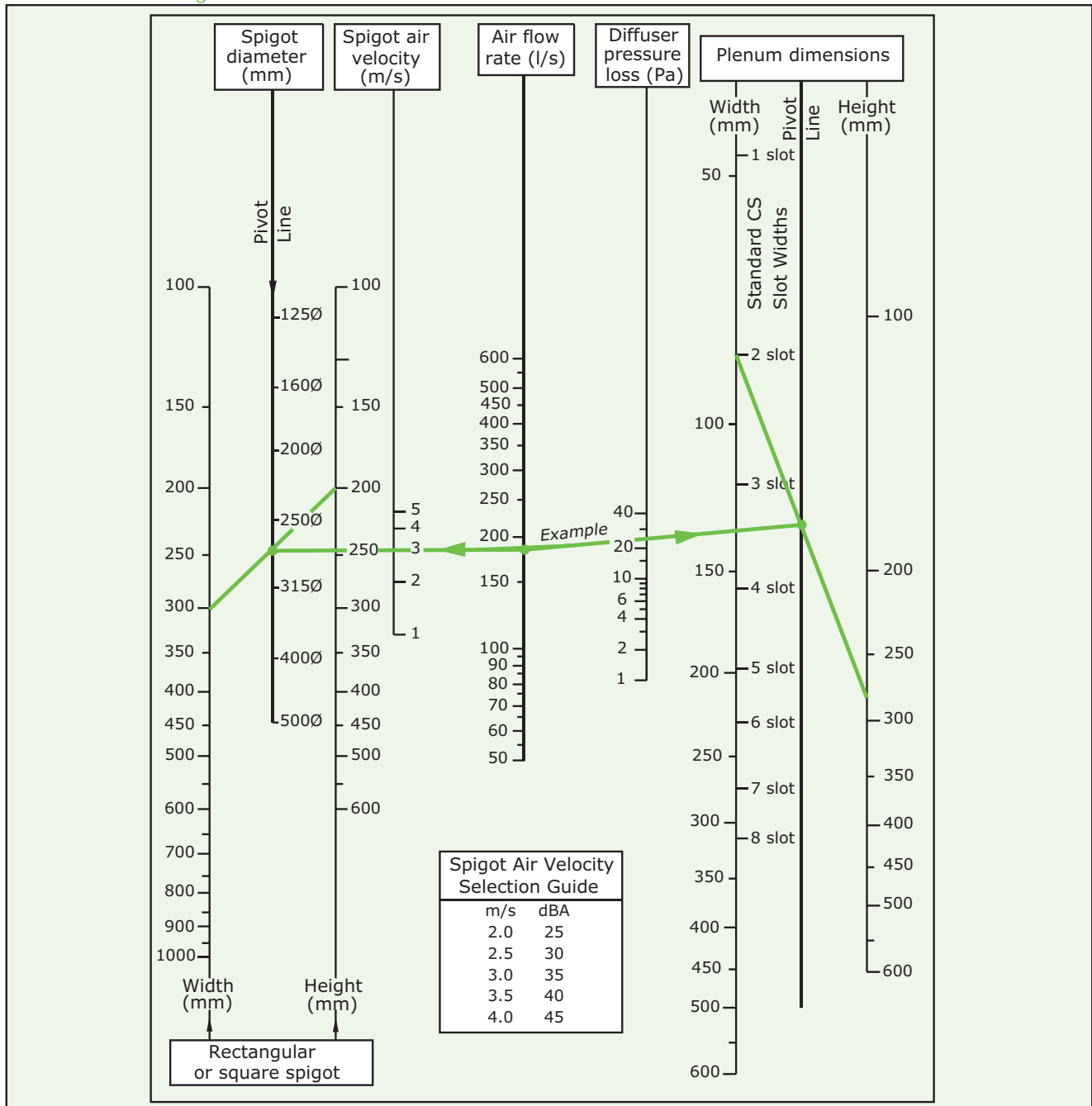





## Waterloo Product Range

### GRILLES

A complete range of products suitable for all wall, ceiling and floor applications. Most grilles are made from aluminium and have a range of fixed or moveable blades designed to give performance whilst remaining aesthetically pleasing to the eye. Grilles are made to customer specified sizes and colours (PPM/G); standard colour PPM9010 (20% Gloss White). The range is complemented by the Aircell range of polymer Grilles.



### DIFFUSERS

Designed to be installed in various ceiling systems, we have a complete range to suit both performance and aesthetic requirements. Most diffusers are made from aluminium and can be ordered with or without plenum boxes for easy duct work. Diffusers can be ordered in customer specified colours (PPM/G); standard colour is PPM 9010 (20% Gloss White). This range is complemented by the Aircell range of polymer Diffusers.



### ACTIVE AND PASSIVE CHILLED BEAMS

The finest quality range of high output active beams, used for ventilated heating and cooling applications. These units have 4 pipe coils to allow heating and cooling circuits to run simultaneously, giving constant and responsive control. The design allows a large optimum capacity and also allows the customer to specify the nozzle type and pitch for individual circumstances.

Active beams are made from steel to a large range of customer specified sizes and as such are suitable for various different ceiling systems. Standard finish is PPM 9010, however other (PPM/G) colours are available on request.

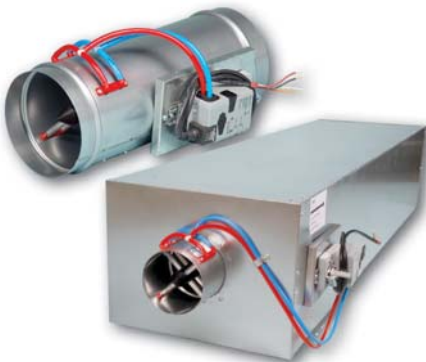

### AIR VOLUME CONTROL DAMPERS

Pressure independent Variable Air Volume and Constant Air Volume dampers made from zintec plate. Most volume dampers are regulated with an electronic motor and sensors and are calibrated to customer specifications before delivery.

The Constant Air Volume damper requires no power source as it is controlled via a mechanical device and calibrated before delivery. All volume dampers can be ordered with a single or double (insulation) skin.

### EXTERNAL LOUVRES

A quality range of products for external wall applications. Made from aluminium, with birdscreen or insect screen options. All louvres are made to customer specified sizes and (PPM/G) colours; standard colour is PPM 9006.



### DISPLACEMENT

A full range of recessed, semi-recessed, floor, wall and corner units providing high ventilation efficiency and excellent comfort. The very low pressure involved also offer quiet installations. Displacement units are available as wall or floor mounted, or indeed integrated within the architectural design.

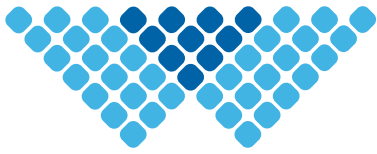

# waterloo

Waterloo Air Products plc

**Head Office:**

Mills Road, Aylesford,  
Maidstone, Kent ME20 7NB  
Tel: +44 (0)1622 711500  
Fax: +44 (0)1622 710648  
email: [sales@waterloo.co.uk](mailto:sales@waterloo.co.uk)  
internet: [www.waterloo.co.uk](http://www.waterloo.co.uk)

**Northern Office:**

Hyde Park House, Cartwright Street,  
Newton, Hyde SK14 4EH  
Tel: +44 (0)161 367 1264  
Fax: +44 (0)161 367 1262  
email: [sales@waterloo.co.uk](mailto:sales@waterloo.co.uk)  
internet: [www.waterloo.co.uk](http://www.waterloo.co.uk)



FM 27823



EMS 590755

All products conform to the Terms and Conditions of Waterloo Air Products plc a copy of which are available upon request. Due to our continuous research and development programme, Waterloo Air Products plc reserve the right to alter products and prices without prior notification.

Copyright Waterloo Air Products plc 2019

Waterloo declare that, at the time of print, all products are in accordance with relevant directives, as identified by HEVAC and other European Organisations and will display the CE Marking where required.