

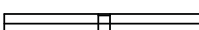

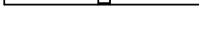

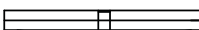

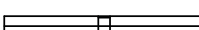
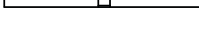
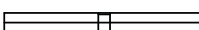
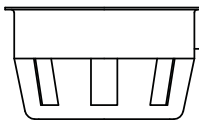

WFO Series Floor Diffuser Component Checklist

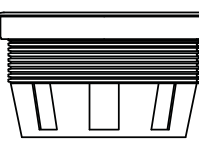
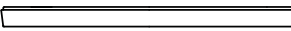

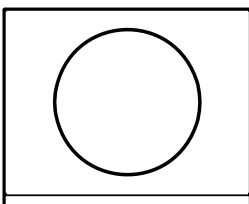
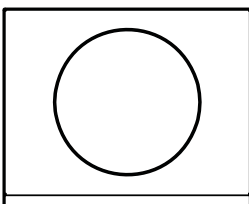
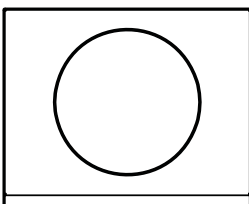

WFO Series Floor Diffuser Component Checklist

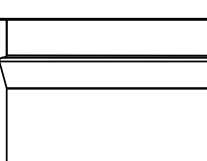
	Disc Only Installation	Tile Installation	Plenum Installation	Slab Installation
 Hook Tool	<input checked="" type="checkbox"/>	<input checked="" type="checkbox"/>	<input checked="" type="checkbox"/>	<input checked="" type="checkbox"/>
 Diffuser Disc - Reversible	<input checked="" type="checkbox"/>			
 Diffuser Disc - Intermediate		<input checked="" type="checkbox"/>		
 Diffuser Disc - Vertical				<input checked="" type="checkbox"/>
<hr/>				
 Diffuser Disc - Reversible		<input checked="" type="checkbox"/>	<input checked="" type="checkbox"/>	<input checked="" type="checkbox"/>
 Diffuser Disc - Intermediate		<input checked="" type="checkbox"/>	<input checked="" type="checkbox"/>	<input checked="" type="checkbox"/>
 Diffuser Disc - Vertical			<input checked="" type="checkbox"/>	<input checked="" type="checkbox"/>
 Damper (Dirt Tray)		<input checked="" type="checkbox"/>	<input checked="" type="checkbox"/>	<input checked="" type="checkbox"/>
 Damper Location Peg		<input checked="" type="checkbox"/>	<input checked="" type="checkbox"/>	<input checked="" type="checkbox"/>
 Mounting Frame		<input checked="" type="checkbox"/>	<input checked="" type="checkbox"/>	<input checked="" type="checkbox"/>
 Locking Collar		<input checked="" type="checkbox"/>	<input checked="" type="checkbox"/>	<input checked="" type="checkbox"/>
<hr/>				
 Collar Fixing Screw			<input checked="" type="checkbox"/>	<input checked="" type="checkbox"/>
 Plenum - 97 Dia Spigot			<input checked="" type="checkbox"/>	
 Plenum - 122 Dia Spigot			<input checked="" type="checkbox"/>	
 Plenum - 147 Dia Spigot			<input checked="" type="checkbox"/>	
<hr/>				
 Clamp Screw				<input checked="" type="checkbox"/>
 Mounting Clamp				<input checked="" type="checkbox"/>
 Cable Tie				<input checked="" type="checkbox"/>
 Steel Sleeve				<input checked="" type="checkbox"/>



Installation

WFO*P Series

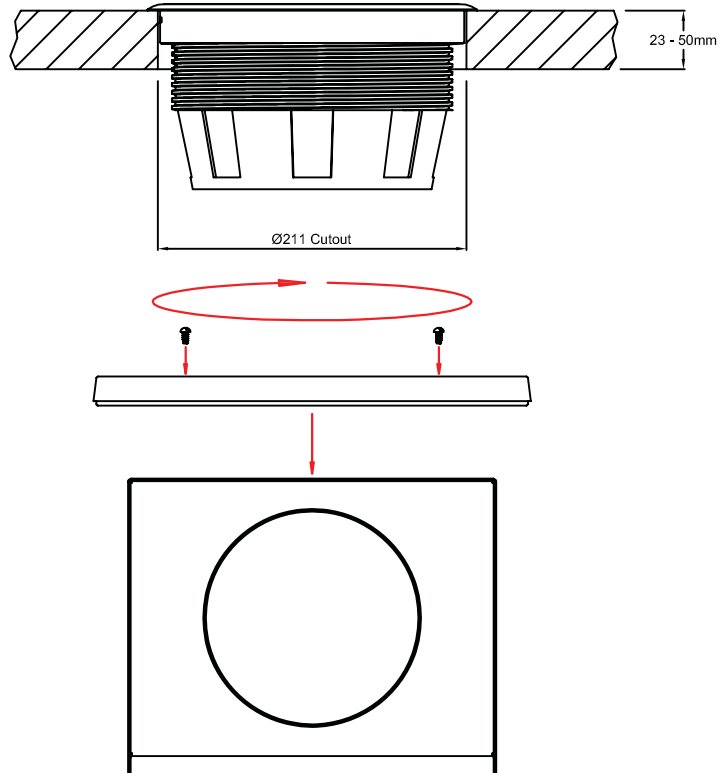

WFO*S Series

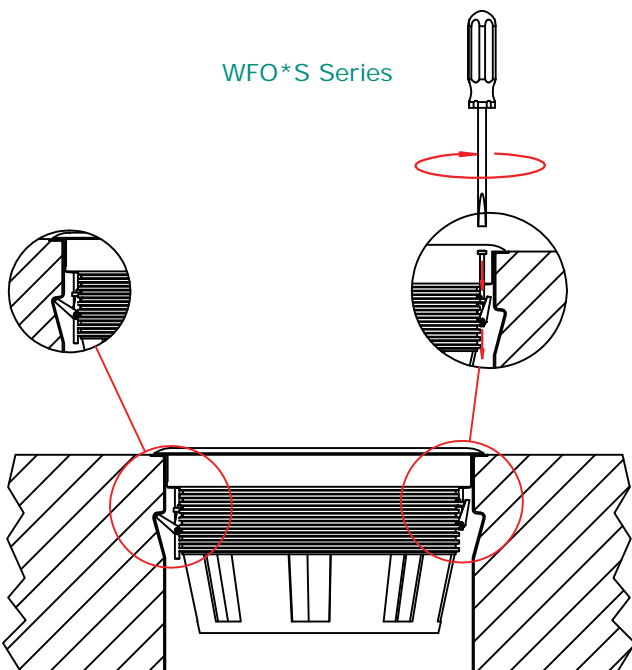

WFO*D Series

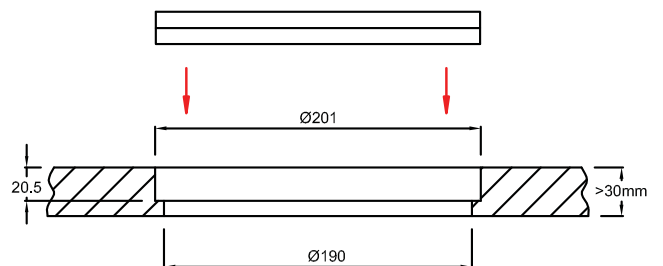



Commissioning

WFO*T Series

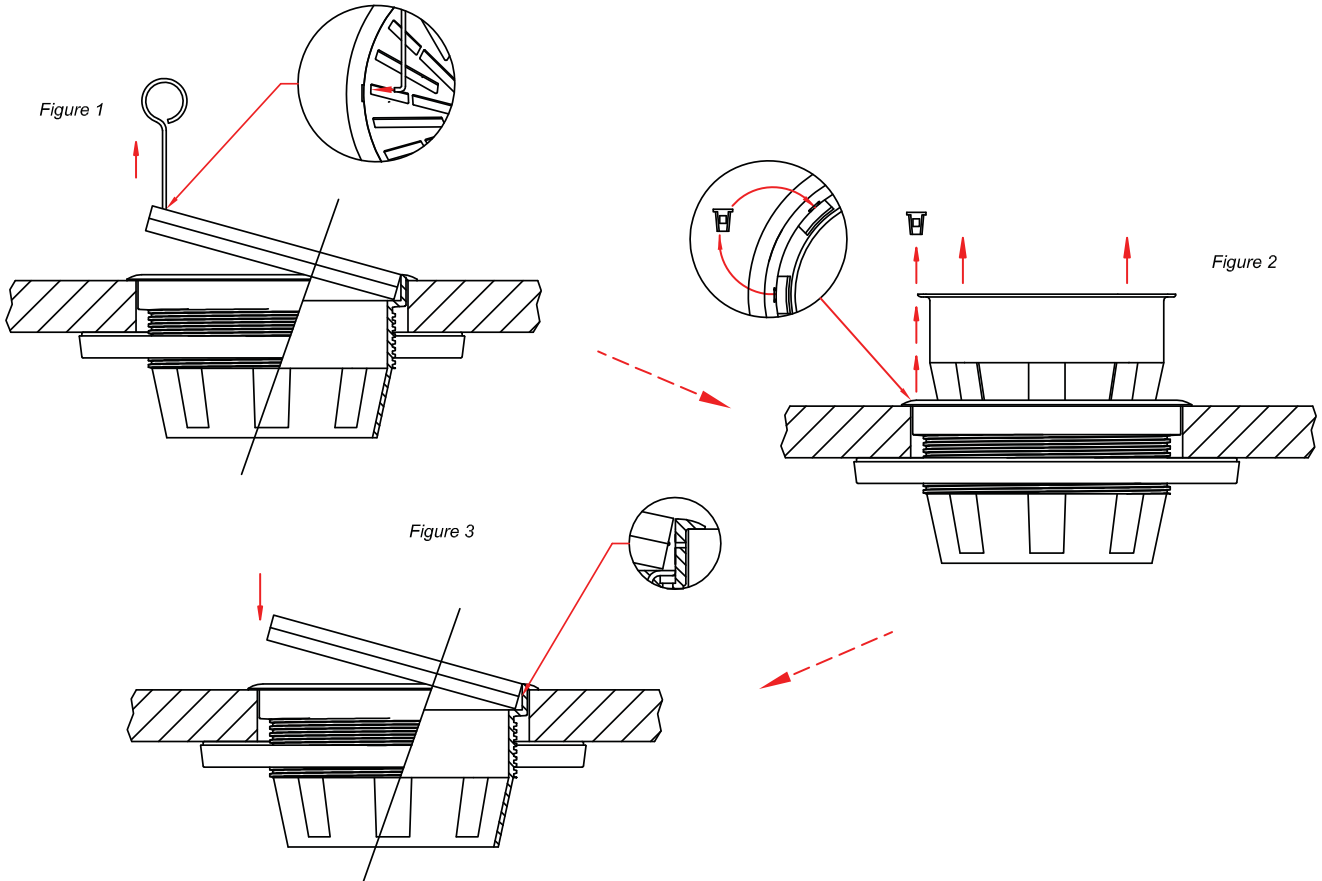

Waterloo Product Range



Waterloo Product Range

GRILLES

A complete range of products suitable for all wall, ceiling and floor applications. Most grilles are made from aluminium and have a range of fixed or moveable blades designed to give performance whilst remaining aesthetically pleasing to the eye. Grilles are made to customer specified sizes and colours (PPM/G); standard colour PPM9010 (20% Gloss White). The range is complemented by the Aircell range of polymer Grilles.



DIFFUSERS

Designed to be installed in various ceiling systems, we have a complete range to suit both performance and aesthetical requirements. Most diffusers are made from aluminium and can be ordered with or without plenum boxes for easy duct work. Diffusers can be ordered in customer specified colours (PPM/G); standard colour is PPM 9010 (20% Gloss White). This range is complemented by the Aircell range of polymer Diffusers.



ACTIVE AND PASSIVE CHILLED BEAMS

The finest quality range of high output active beams, used for ventilated heating and cooling applications. These units have 4 pipe coils to allow heating and cooling circuits to run simultaneously, giving constant and responsive control. The design allows a large optimum capacity and also allows the customer to specify the nozzle type and pitch for individual circumstances.

Active beams are made from steel to a large range of customer specified sizes and as such are suitable for various different ceiling systems. Standard finish is PPM 9010, however other (PPM/G) colours are available on request.

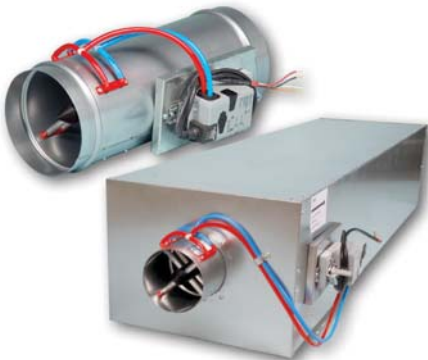

AIR VOLUME CONTROL DAMPERS

Pressure independent Variable Air Volume and Constant Air Volume dampers made from zintec plate. Most volume dampers are regulated with an electronic motor and sensors and are calibrated to customer specifications before delivery.

The Constant Air Volume damper requires no power source as it is controlled via a mechanical device and calibrated before delivery. All volume dampers can be ordered with a single or double (insulation) skin.

EXTERNAL LOUVRES

A quality range of products for external wall applications. Made from aluminium, with birdscreen or insect screen options. All louvres are made to customer specified sizes and (PPM/G) colours; standard colour is PPM 9006.



DISPLACEMENT

A full range of recessed, semi-recessed, floor, wall and corner units providing high ventilation efficiency and excellent comfort. The very low pressure involved also offer quiet installations. Displacement units are available as wall or floor mounted, or indeed integrated within the architectural design.

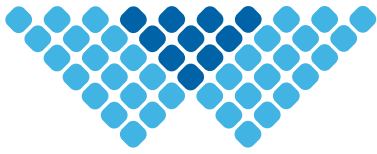

waterloo

Waterloo Air Products plc

Head Office:

Mills Road, Aylesford,
Maidstone, Kent ME20 7NB
Tel: +44 (0)1622 711 500
Fax: +44 (0)1622 710 648
email: sales@waterloo.co.uk
internet: www.waterloo.co.uk

Northern Office:

Hyde Park House, Cartwright Street,
Newton, Hyde SK14 4EH
Tel: +44 (0)161 367 1264
Fax: +44 (0)161 367 1262
email: sales@waterloo.co.uk
internet: www.waterloo.co.uk



FM 27823



EMS 590755

All products conform to the Terms and Conditions of Waterloo Air Products plc a copy of which are available upon request. Due to our continuous research and development programme, Waterloo Air Products plc reserve the right to alter products and prices without prior notification.

Copyright Waterloo Air Products plc 2019

Waterloo declare that, at the time of print, all products are in accordance with relevant directives, as identified by HEVAC and other European Organisations and will display the CE Marking where required.